

Diode Pumped Nd:YLF Diode Pumped Nd:YLF Diode Pumped Nd:YLF

Terra™

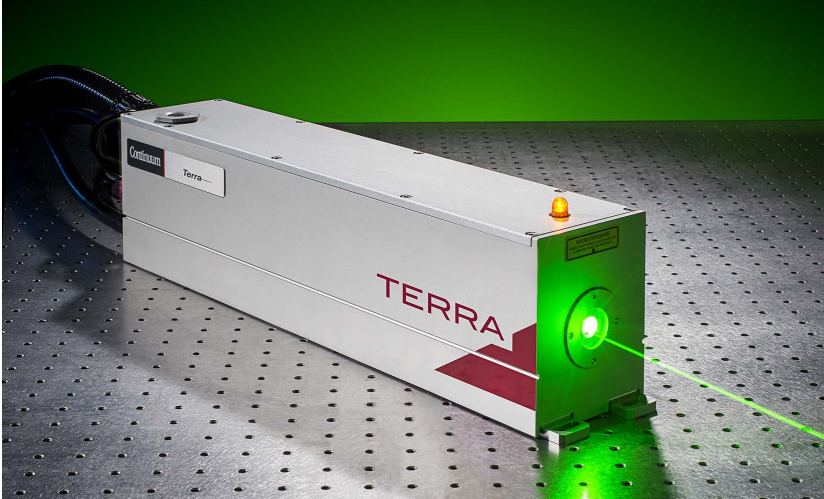

Terra, the diode pumped Nd:YLF laser

The Terra Nd:YLF laser is the smallest laser in its class. It produces high average power (>50 W) at kilohertz repetition rates. Our proprietary intracavity frequency doubling results in high conversion efficiency, without resorting to the tight focusing in the doubling crystal, which is normally necessary in an extracavity design and leads to possible optical damage. Our proprietary pump chamber design further increases the system's overall efficiency. High pulse energy, smallest M^2 , and small jitter are all available in this extremely compact and highly ruggedized package, optimized for pumping Ti:Sapphire amplifiers.

>30 mJ pulse energy at 1kHz

Average power >50 W @ 3 kHz

Repetition rates up to 10 kHz

Exceptional beam pointing and power stability

Compact, rugged & hermetically sealed laser head

Quick & easy diode module replacement (3min)

Proprietary pump chamber design for optimal beam quality

Optimized for ultrafast amplifier pumping

Terra Energy Stability

Terra-527-40-M output energy stability measurement

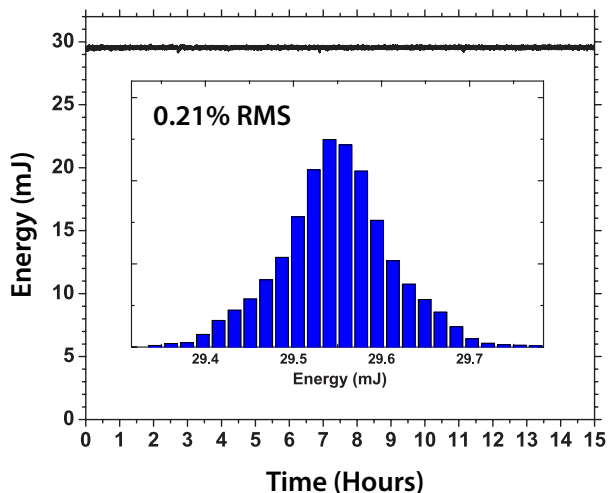

Terra Beam Profile

Uniform Spatial Profile is optimized for Ti:Sapphire pumping

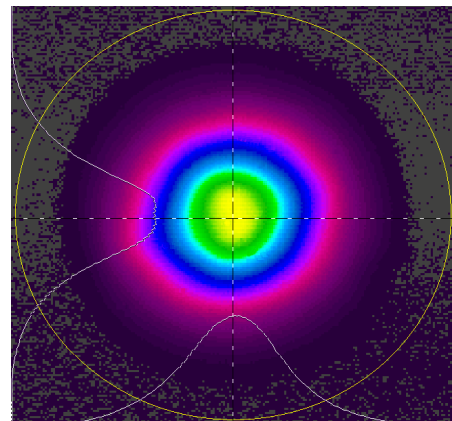

Terra Specifications

Description	527-50-M	527-40-M	527-30-M	527-20-M
Transverse Mode	MM	MM	MM	MM
Pulse Energy at 0.1-1 kHz (mJ) ¹	30	25	20	15
Pulse Repetition Rate (kHz) ²	0.1-10	0.1-10	0.1-10	0.1-10
Average Power @ 3 kHz (W)	50	40	30	20
Pulsewidth (ns)	<140	<150	<160	<170
Energy Stability (% RMS)	<0.5	<0.5	<0.5	<0.5
Beam Pointing Stability (μrad)	<25	<25	<25	<25
Beam Diameter at Output (mm) ^{3, 4}	2.5	2.5	2.5	2.5
Beam Quality (M ²)	<12	<12	<12	<12
Beam Divergence (mrad) ³	8	8	8	8
Time Jitter (ns RMS)	<3	<3	<3	<3
Polarization (vertical/horizontal)	H	H	H	H

Notes

1. All specifications at 1kHz unless otherwise noted
2. Single shot to 1 kHz available with external trigger
3. Typical measurement (±10%)
4. Measured at 13.5% level at output window

As a part of our continuous improvement program, all specifications are subject to change without notice.

Laser System Output Characteristics Terra 527-50-M Performance Curves

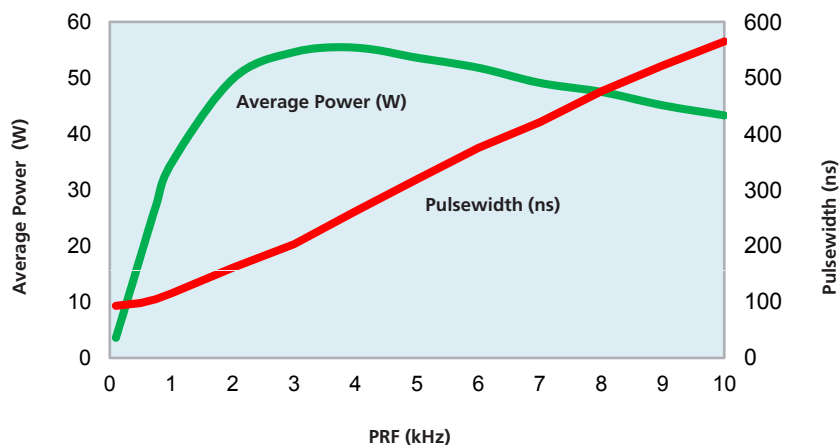
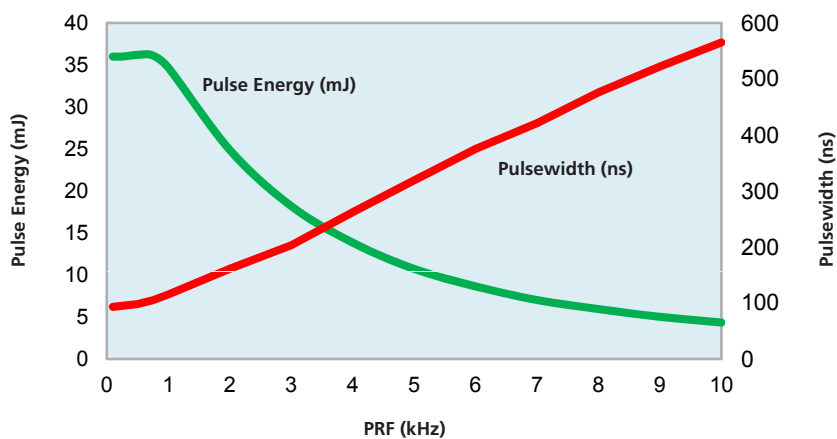

Terra System Requirements

Size	Optical Head (LxWxH)	A) 551 x 102 x 127 mm (21.7 x 4.0 x 5.0 in) mm models; B) 627 x 102 x 127 mm (24.7 x 4.0 x 5.0 in) TEM ₀₀ mode
	Power Supply (LxWxH) Chiller (LxWxH)	509 x 483 x 177 mm (20.0 x 19.0 x 7.0 in) 699 x 483 x 411 mm (27.5 x 19.0 x 16.2 in)
Weight	Optical Head	A) 9 kg (20 lbs) B) 10.5 kg (23 lbs)
	Power Supply Chiller	17.7 kg (39 lbs) 55 kg (122 lbs)
Cooling		Air-Water; Water-Water cooling option available
Electrical Service	Power Supply	Single-phase: 208-240 VAC, 50/60 Hz Operating current: 5A, Max current: 10A
	Chiller	Single-phase: 230 ±10% VAC, 50/60 Hz Operating current: 10A, Max current: 15A
Temperature & Humidity	Operating Temperature Storage Temperature Relative Humidity	15 to 35° C -20 to 50° C 8-80%, non-condensing
Umbilical Length		3.65 m (12.0 ft)
Control Interface	Serial Interface	RS-232, Ethernet
	Rear Connections	External beam enable, External trigger, Analog current control, Analog RF attenuation control, Digital alert output
	Control Software	MS Windows-based Laser Commander

Terra Physical Layout

All dimensions are in inches [mm]

SIDE VIEW

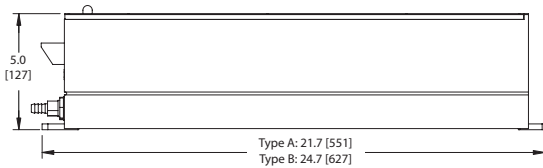

FRONT VIEW

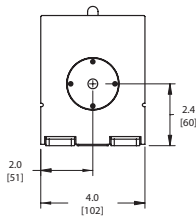

Terra Power Supply

FRONT VIEW Power Supply

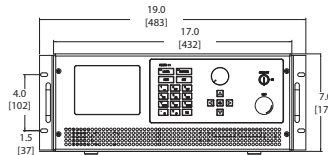

SIDE VIEW

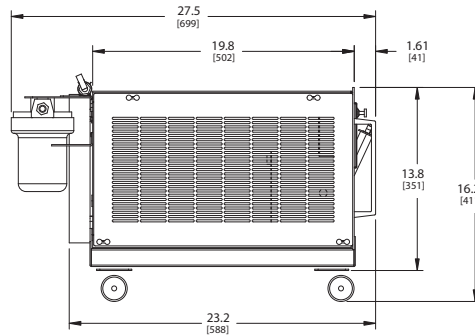
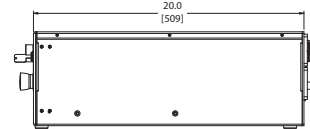

SIDE VIEW Chiller

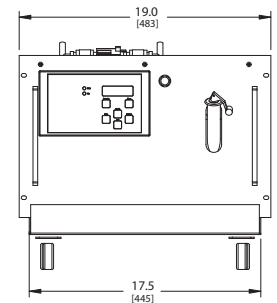

FRONT VIEW



MAXIMUM OUTPUT: 50 mJ
PULSE DURATION: 100-200 ns
WAVELENGTH: 527 nm
IEC 60825-1:2007-03

Continuum
3150 Central Expressway, Santa Clara, CA
Tel (408) 727-3240 Fax (408) 727-8237
USA Sales (866) 532-1064
www.continuumlasers.com
992-0096, Rev. A, 12/13

